

Boomshakalaka - Excerpt
Megill & Company
Choreography by: Beth Megill
Notation by: Brooklynn Reeves-Mallett
Draft - July 13, 2020
Video Link: https://www.youtube.com/watch?v=Gps_m7zBVow

Key

- ∠ Bound Flow
-  General raised spirits and increased emotional intensity throughout entire piece.

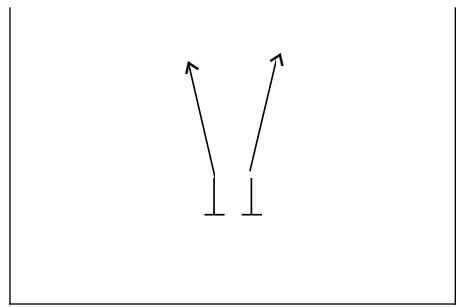

7-8

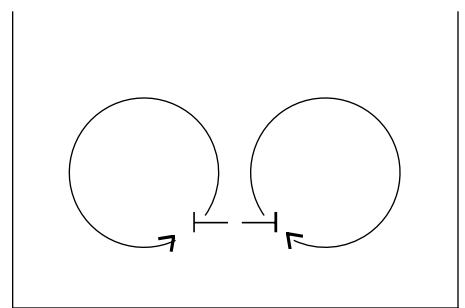

5-6

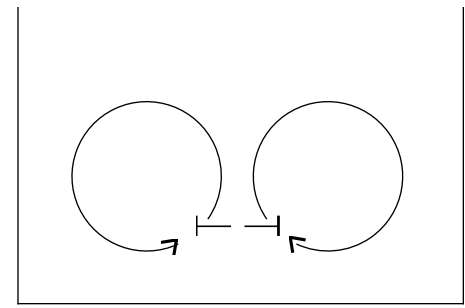

3-4

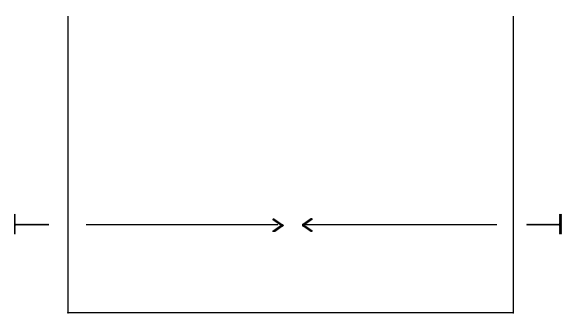

1-2

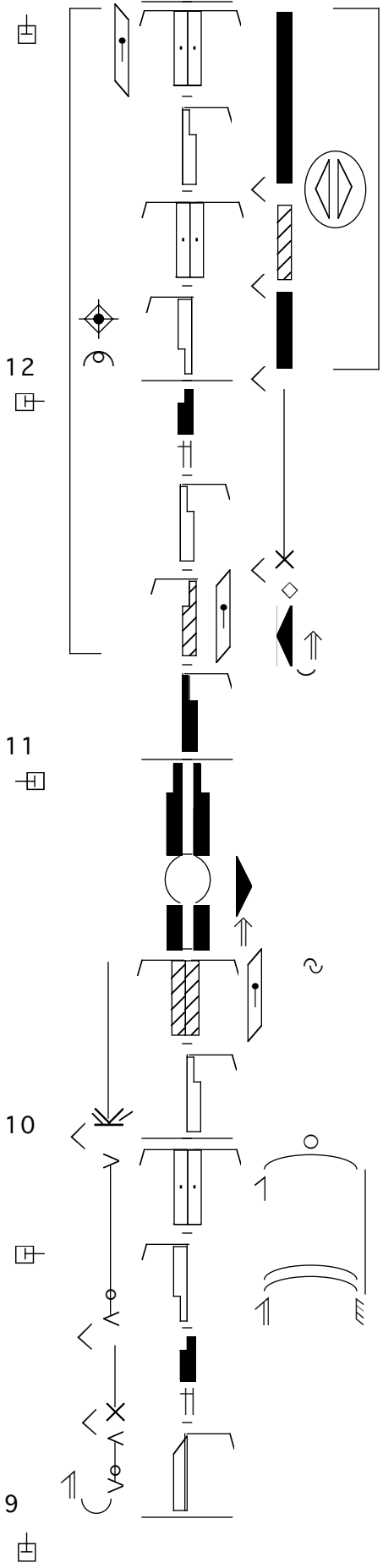

BETH & BROOKLYNN

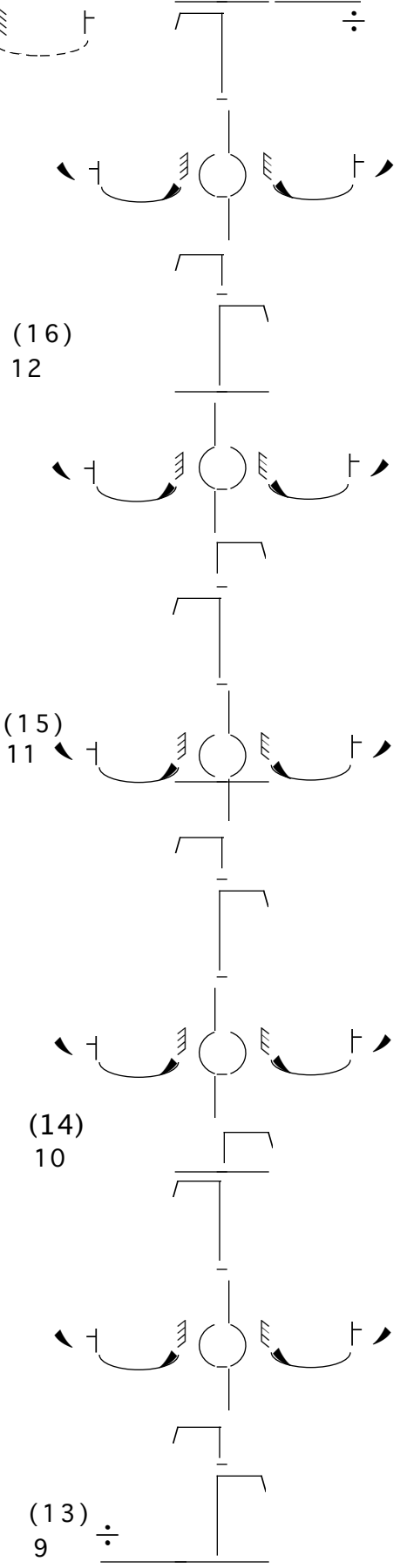

ERIN, JASMINE, & RYAN

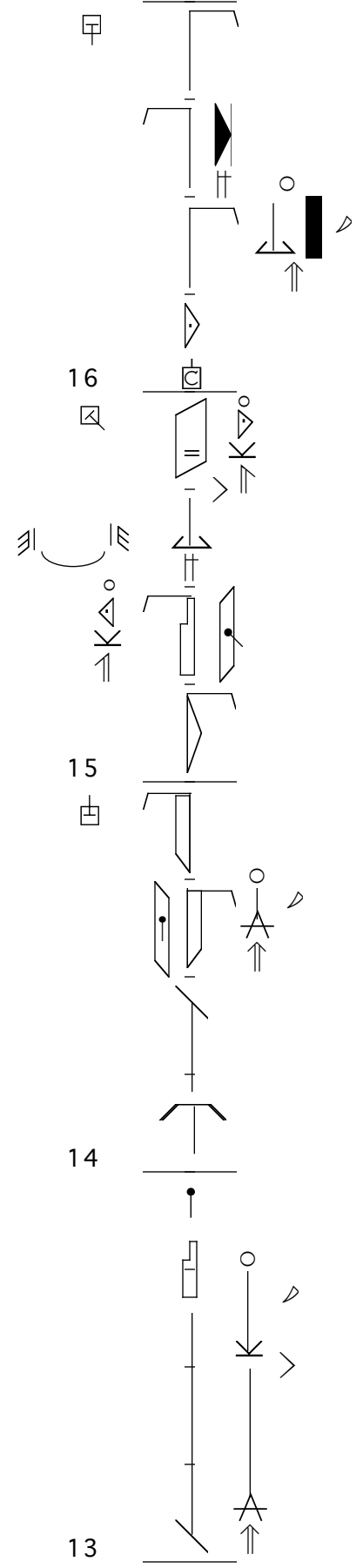

BETH & BROOKLYNN

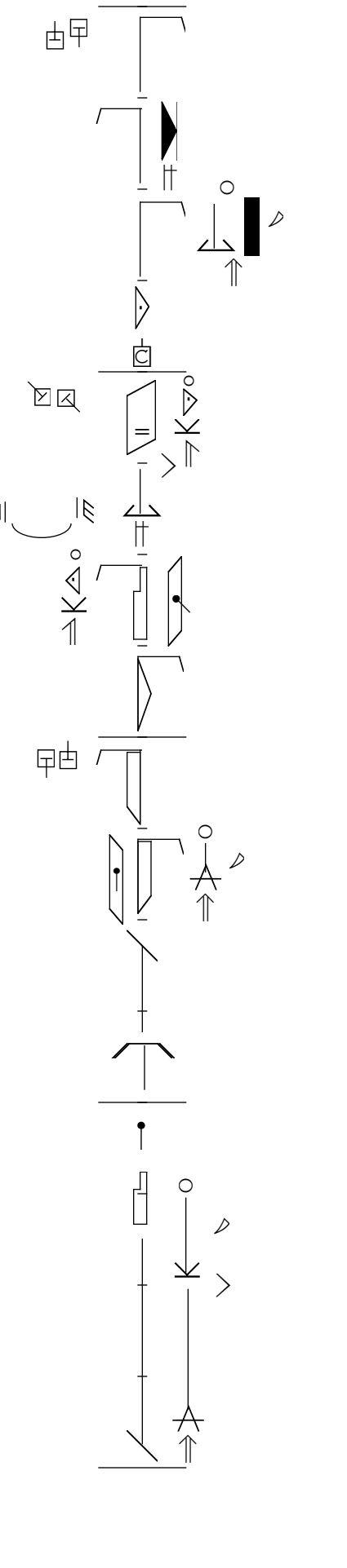
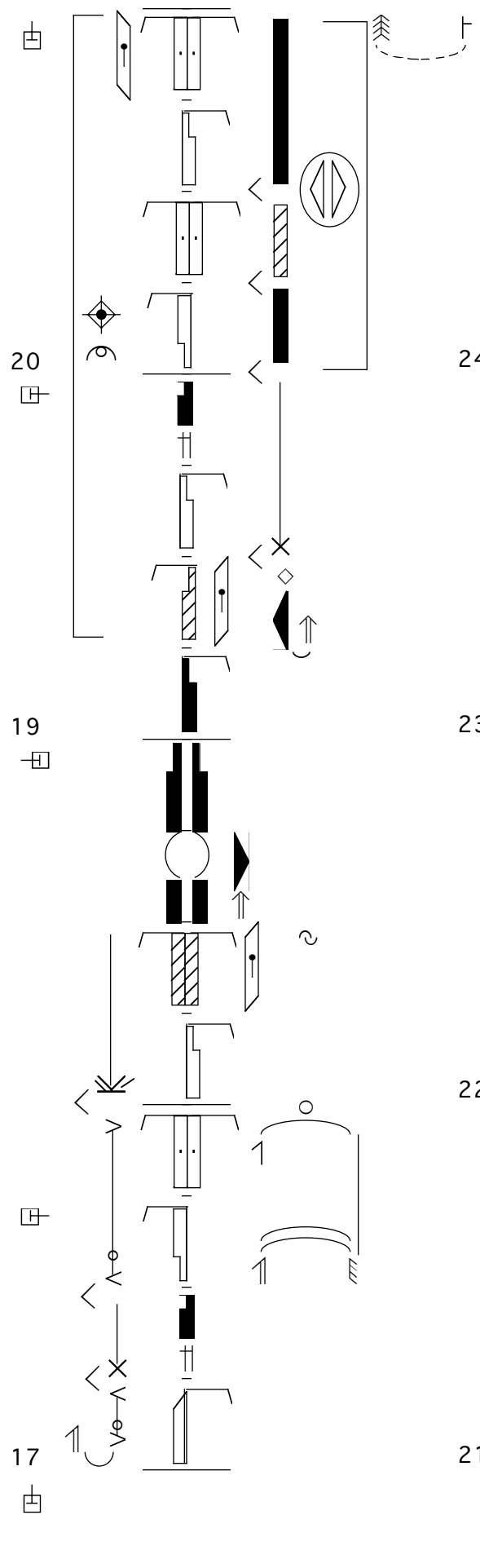
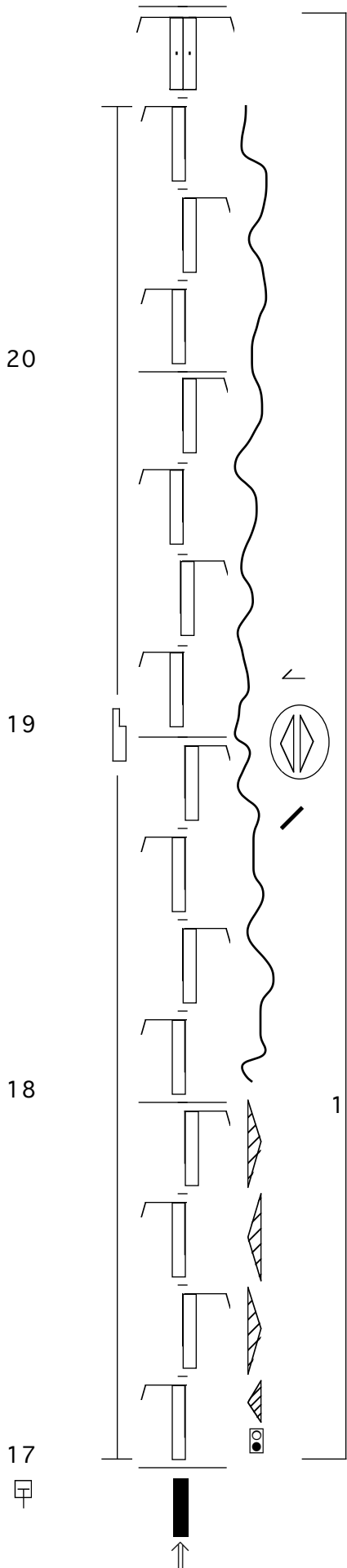

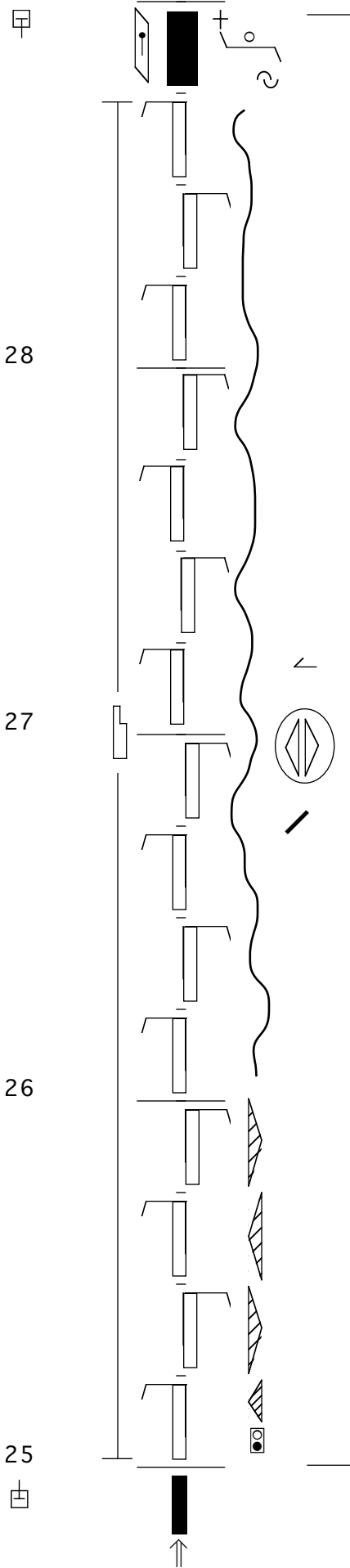

BETH, BROOKLYNN,
ERIN, JASMINE & RYAN

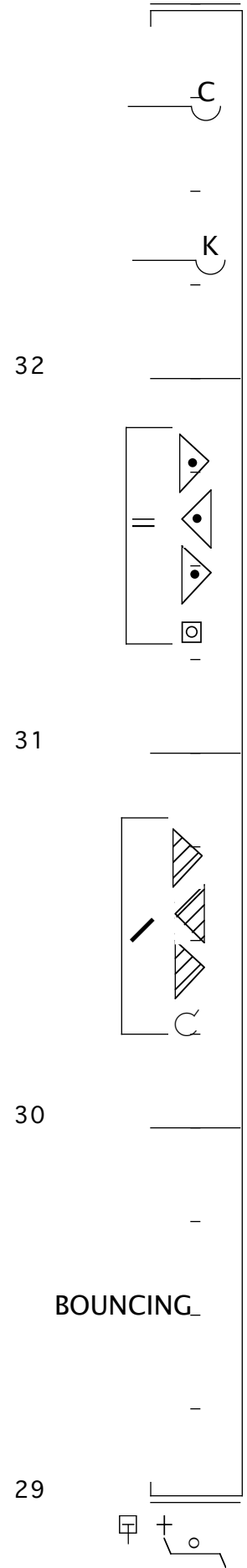

KARISSA & CORDELIA

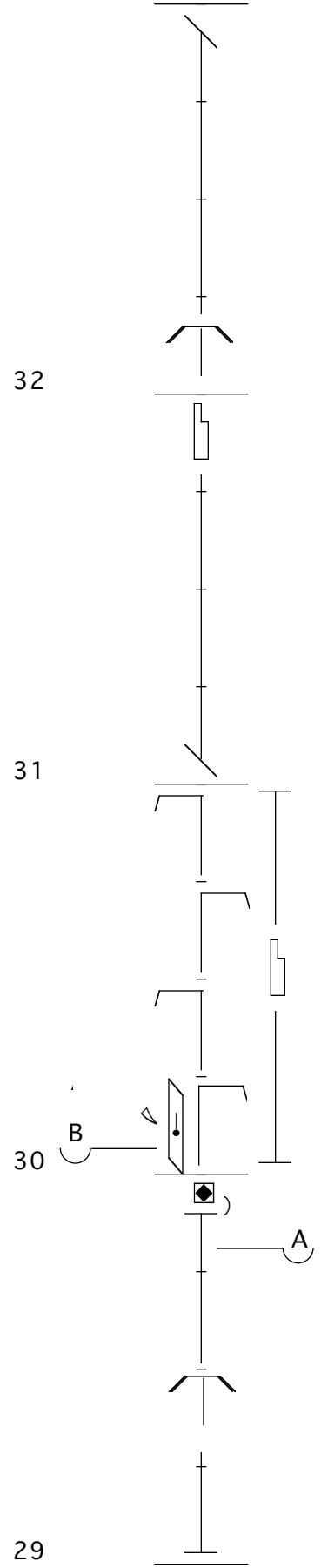

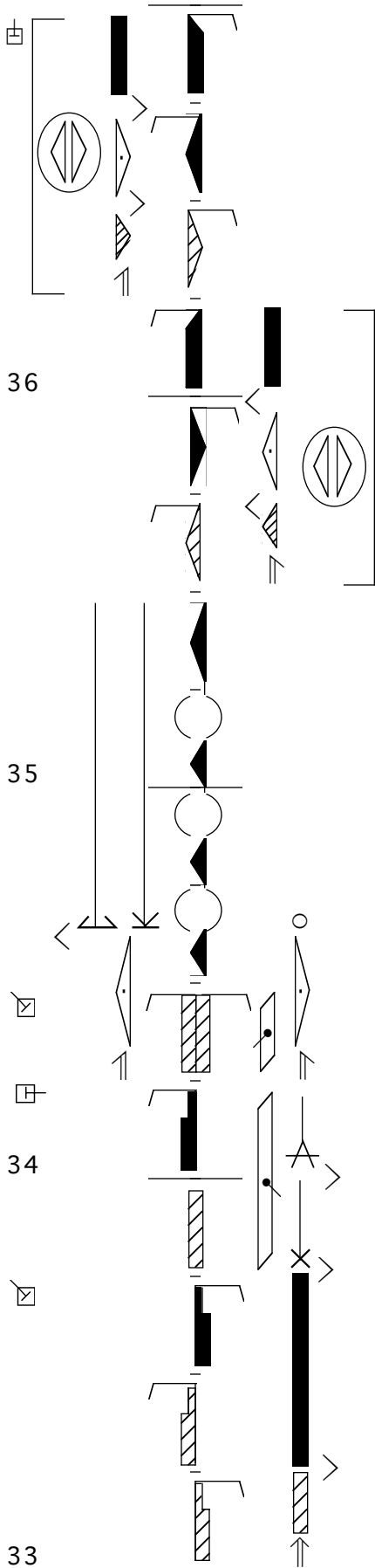

KARISSA & CORDELIA

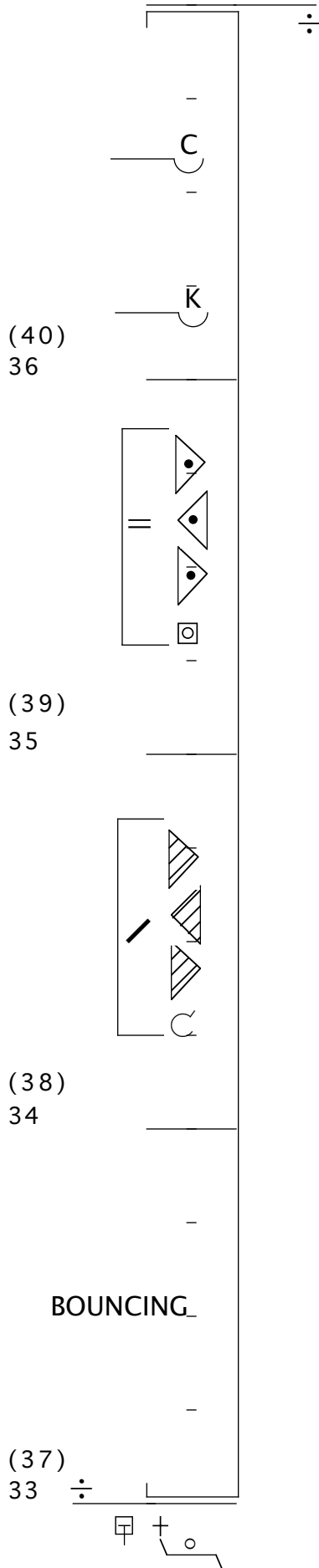

BETH, BROOKLYNN,
ERIN, JASMINE & RYAN

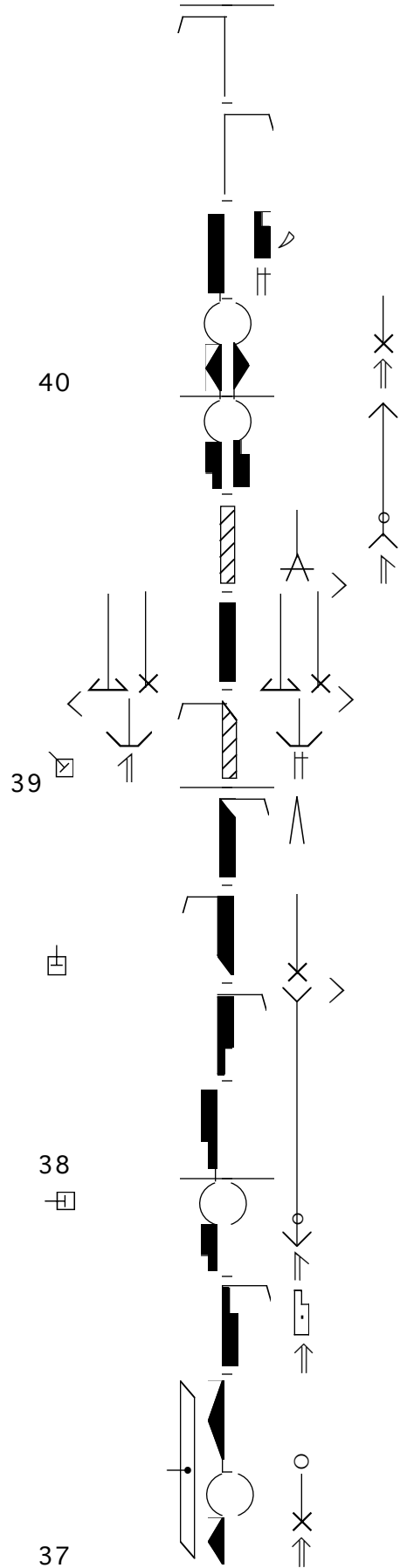

KARISSA & CORDELIA

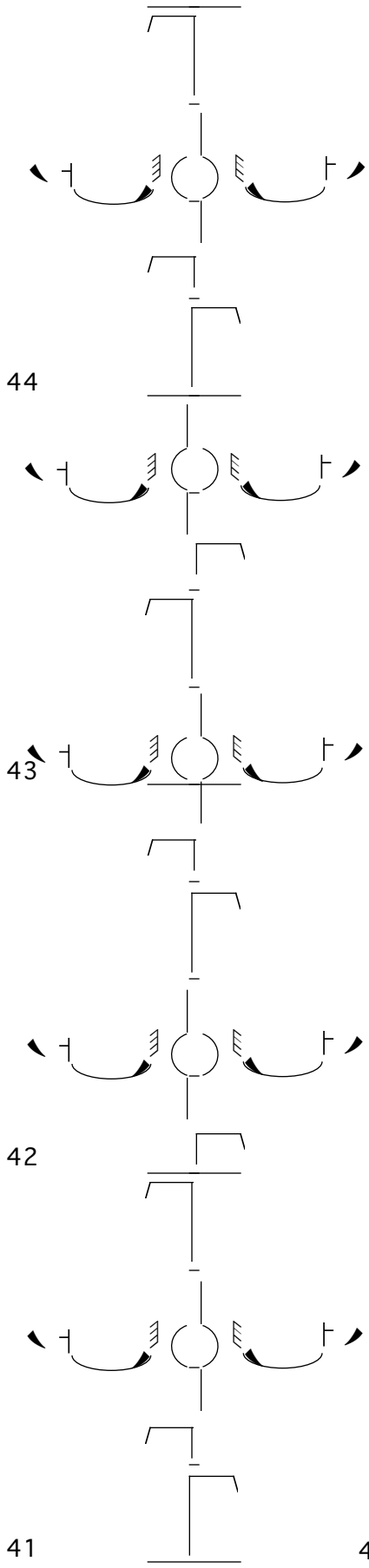

41 ALL

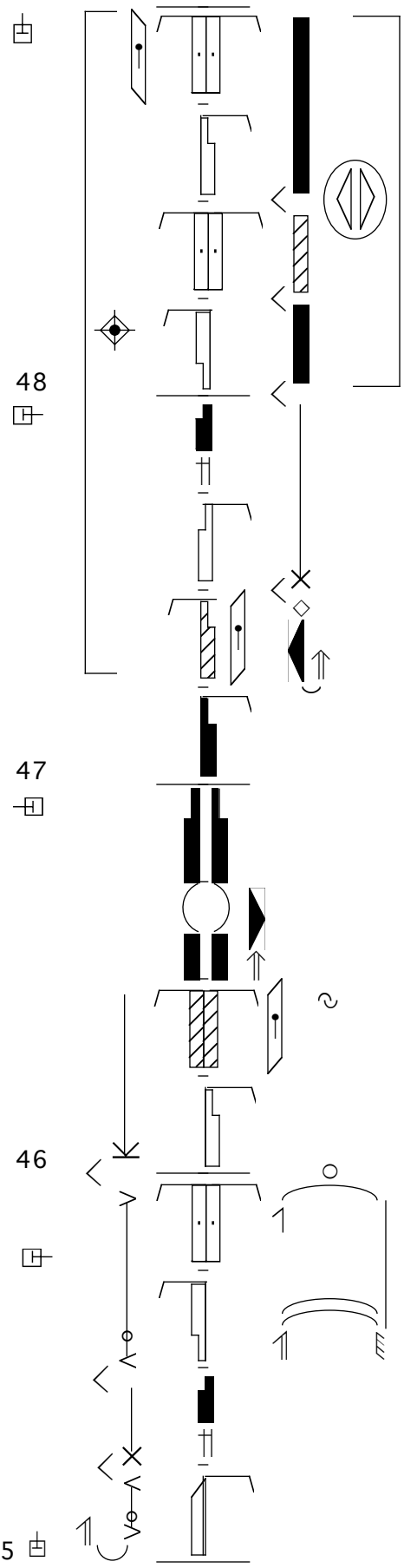

45 ALL

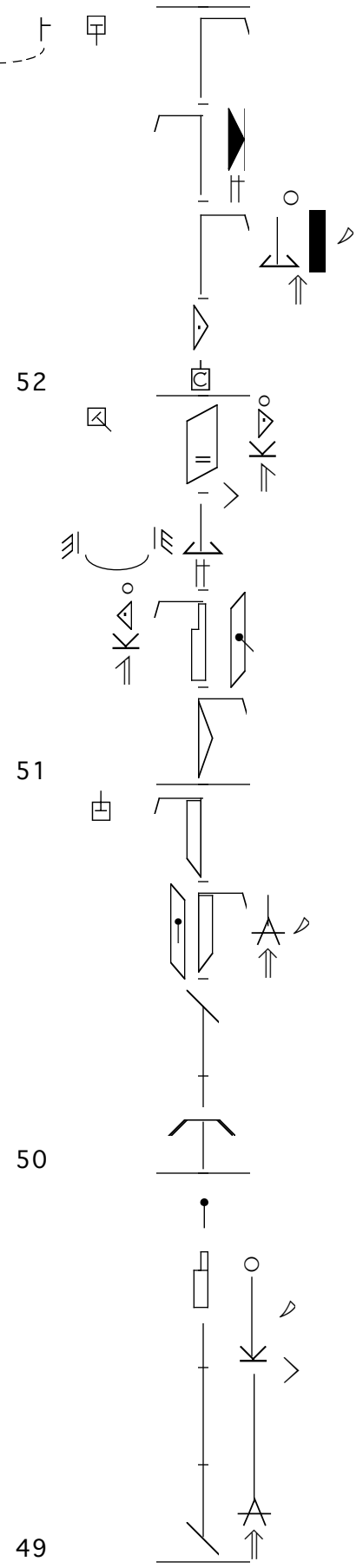

49 ALL

甲

56

55

甲

54

乙

53

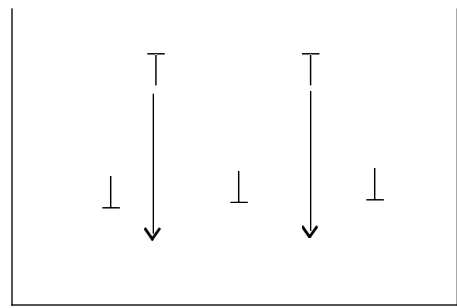
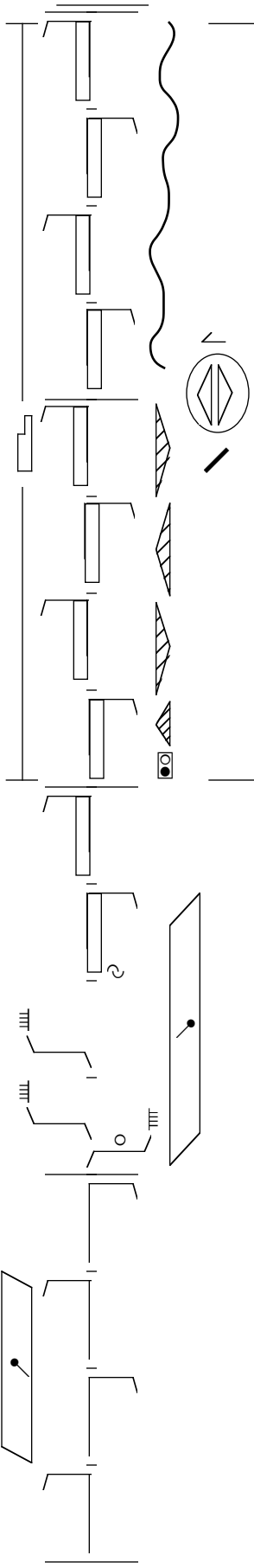

17-20

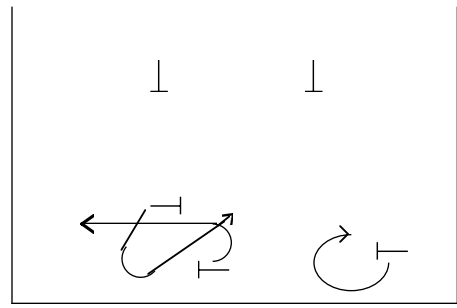

15-16

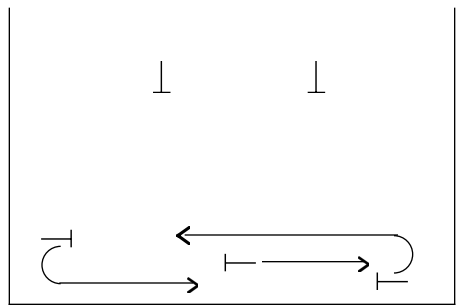

13-14

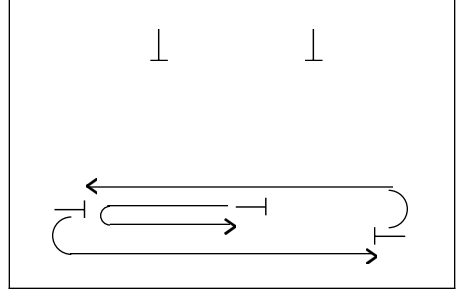

11-12

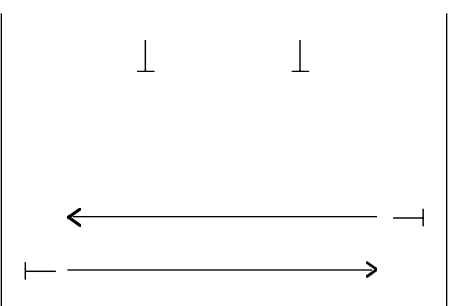

9-10

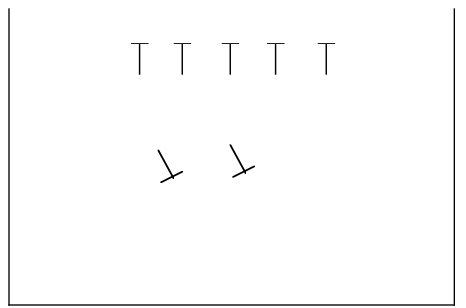

33

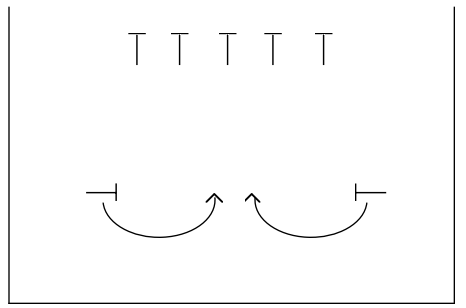

31-32

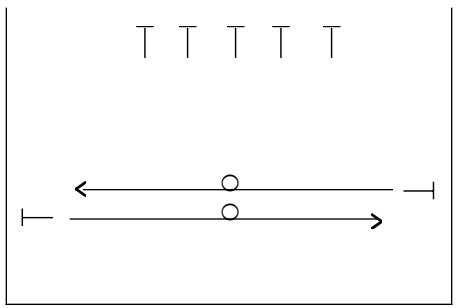

29-30

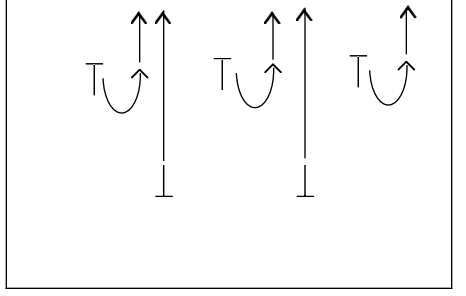

25-28

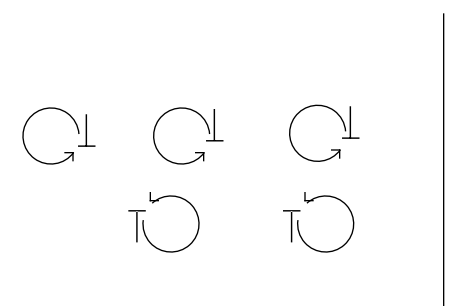

21

ALL

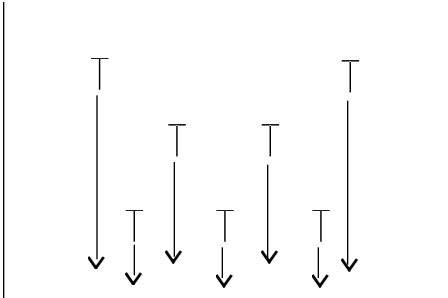

55-56

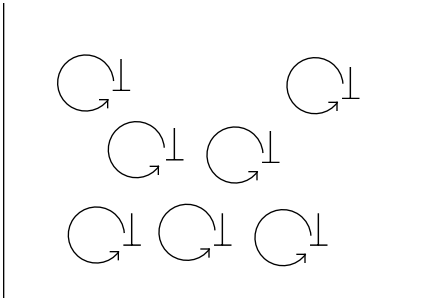

49-50

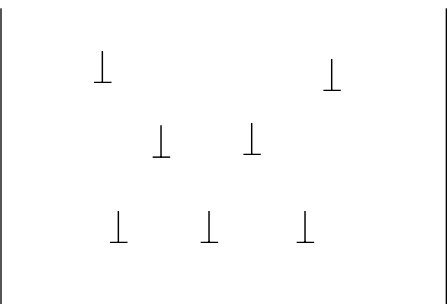

45

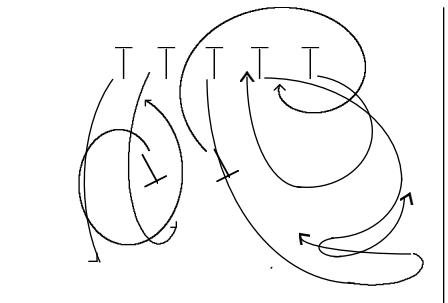

41-44